

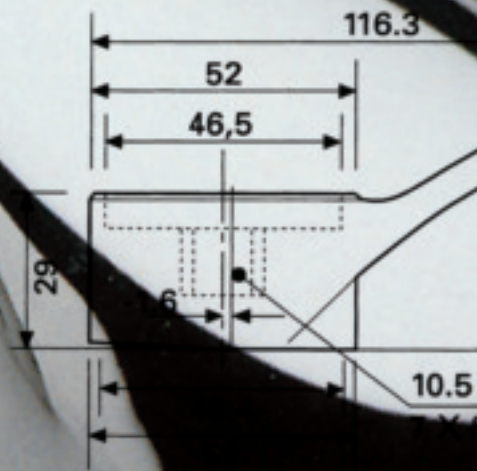

Componenti per rubinetteria

Tap components



L'azienda che fu fondata da 3 fratelli è oggi composta da un organico di 100 dipendenti e produce articoli vari in ZAMA pressofusa su una superficie totale di oltre 12.500 mq.

Stilopress è specializzata nella realizzazione di articoli tecnici e a disegno per svariati settori (casalinghi, sanitari, illuminazione, ferramenta, ecc.) e nella produzione di leve monocomando per la rubinetteria (fornitrice abituale di importanti gruppi internazionali con leve personalizzate ed a catalogo). Qualità, servizio e rispetto dei tempi di consegna sono caratteristiche primarie della nostra azienda che ogni giorno punta al totale soddisfacimento del cliente.

Stilopress S.r.l. segue le procedure ed i controlli di qualità dettati dalle normative EN ISO 9001:2000. Un punto di forza della nostra azienda è la possibilità di realizzare internamente l'intero ciclo produttivo.

Siamo in grado di mettere a disposizione del cliente la nostra esperienza di oltre 50 anni di pressofusione e di consigliare modifiche in fase di realizzazione di nuovi pezzi che possano migliorare il risultato del prodotto finale.

The company, founded by three brothers, has got now a staff of 100 employees. Main activity of the company is the manufacture of die-cast ZAMAK items in premises covering over 12,500 sqm. Stilopress has been specialising in the manufacture of technical items and articles against customer's drawing for various sectors (household, sanitary, lighting, hardware areas etc.), as well as of single-drive levers for taps and mixers (being regular supplier of tailor-made and catalogue levers to important international groups).

Quality, service and observance of lead times are the prerequisites of our company, whose daily goal is total customer's satisfaction.

Stilopress Srl comply with quality procedures and inspections as established in the standards EN ISO 9001:2000. Our company's strength results from the possibility of performing the whole production cycle inside our premises.

We place at customers' disposal our over-fifty-year experience in die-casting and can recommend any adjustment during the designing of new pieces so to improve the outcome of final products.

Un continuo
e costante
aggiornamento,
la ricerca
di un design
sempre all'avanguardia
e la possibilità
di avere grosse scorte
a magazzino,
ci permettono di
garantire qualità
e consegne puntuali.



*The continuous and
steady up dating, the research
of an always new
and modern design, and the
possibility to have big stocks,
enable us to guarantee
quality and deliveries on time.*

Leve per cartuccia Ø 35

Levers for cartridges Ø 35

Chiuse
Closed

Art. 102

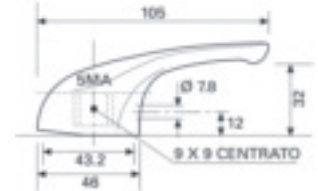

Art. 109

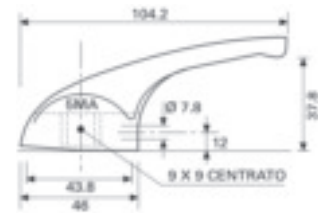

Art. 113

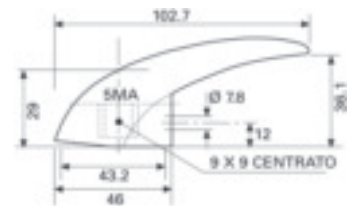

Art. 119

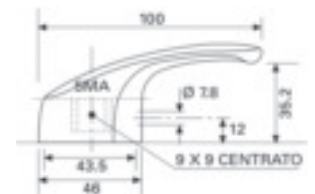

Art. 125

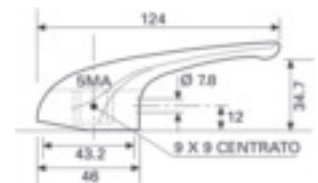

Art. 127

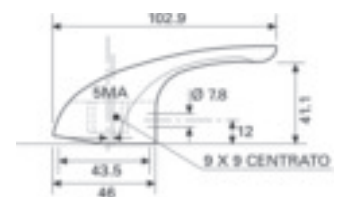

Leve monocomando Single-control levers

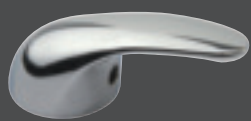
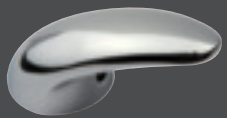
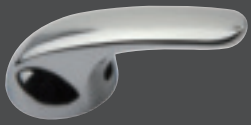



Art. 129

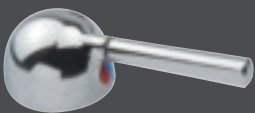

Art. 131

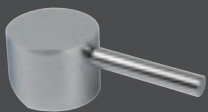

Art. 135

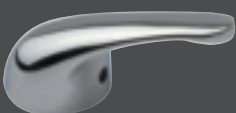

Art. 149



Art. 157



Art. 163



Art. 163M

Leve monocomando Single-control levers

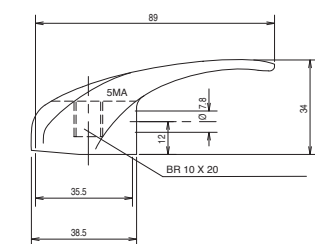
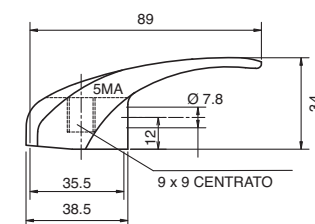
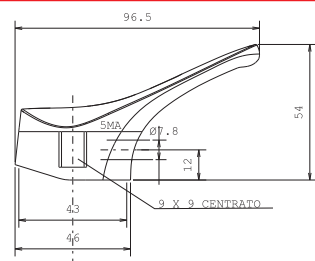
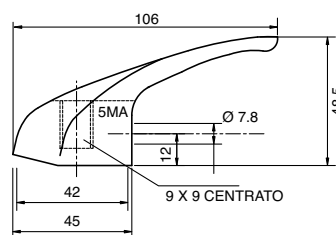
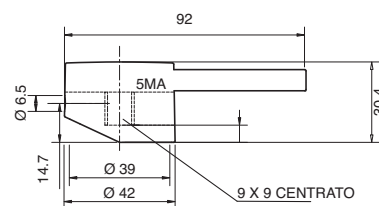
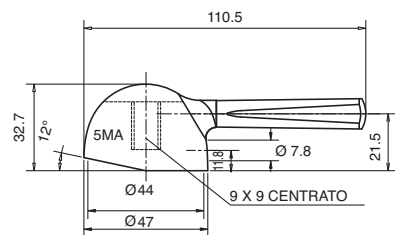
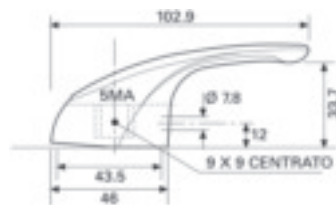



Leve monocomando *Single-control levers*

6

Aperte
Open
Art. 107

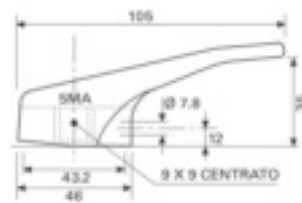

Art. 117

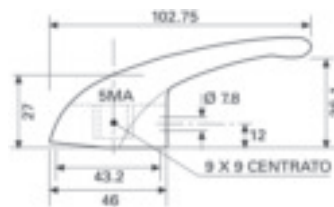

Art. 121

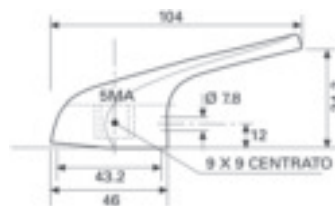

Leve per cartuccia Ø 40

Levers for cartridges Ø 40



Chiuse con placchetta
Closed with plastic cup

Art. 103

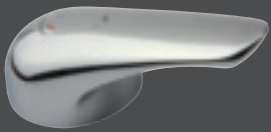
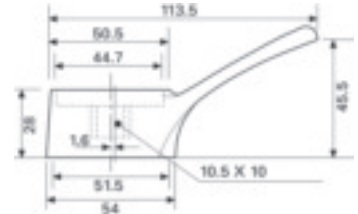

Art. 115

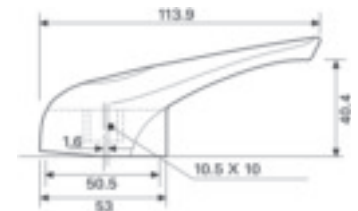

Aperte con placchetta
Open with plastic cup

Art. 101

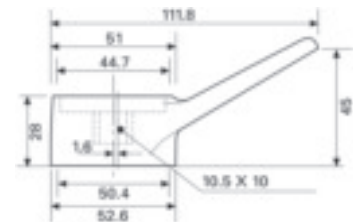

Art. 110

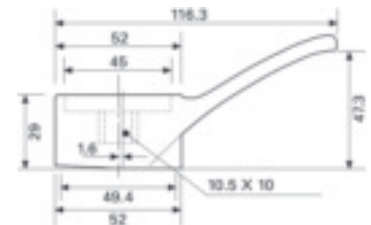

Chiuse
Closed

Art. 104

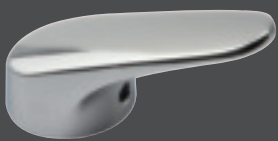
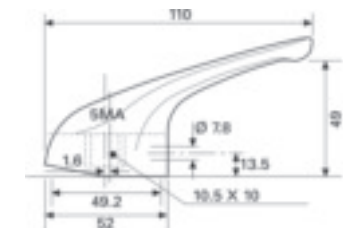

Art. 111

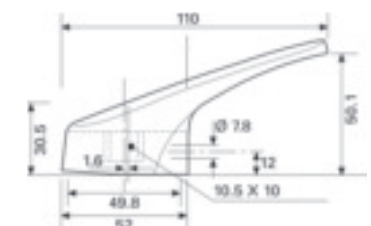

Leve monocomando Single-control levers



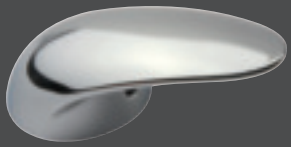

Art. 112

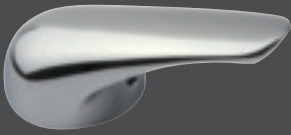
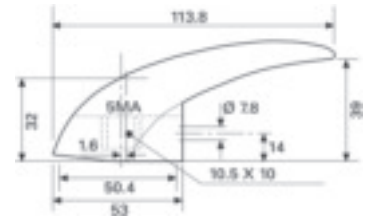

Art. 114

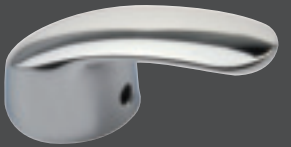
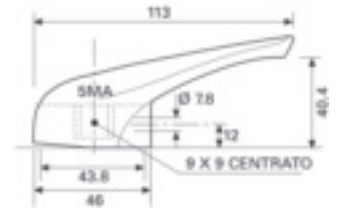

Art. 118

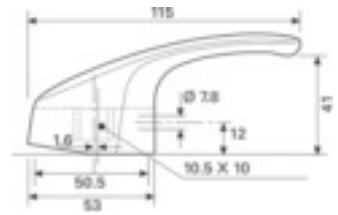

Art. 122

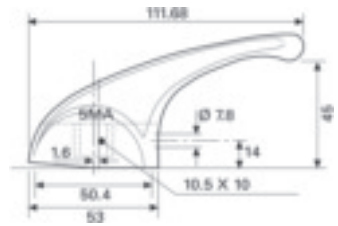

Art. 124

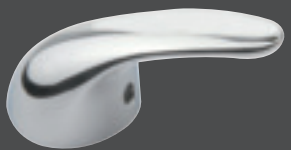
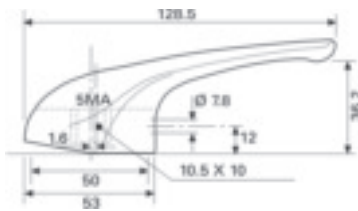

Art. 126

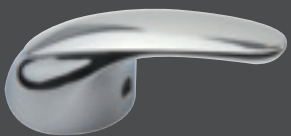
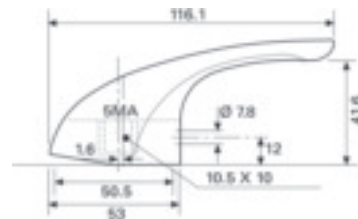

Art. 128

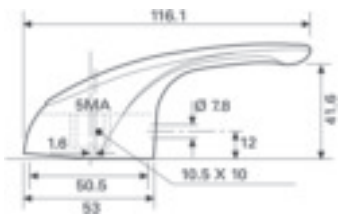

Leve monocomando Single-control levers



Leve monocomando Single-control levers

Art. 130

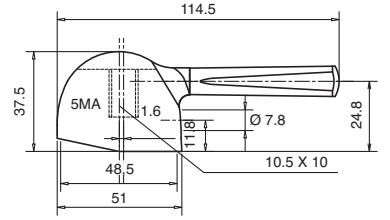

Art. 136

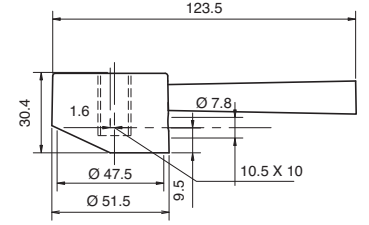

Art. 139

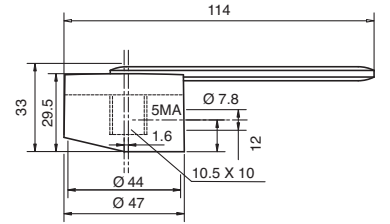
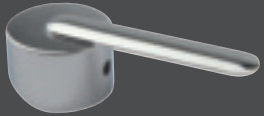

Art. 141

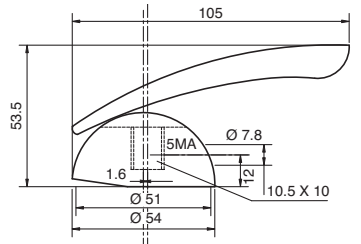
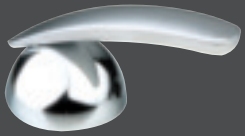

Art. 142

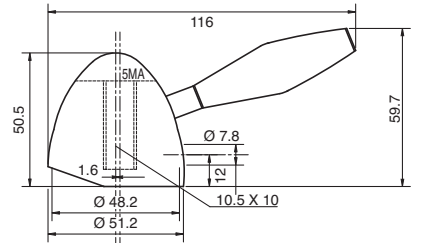

Art. 143

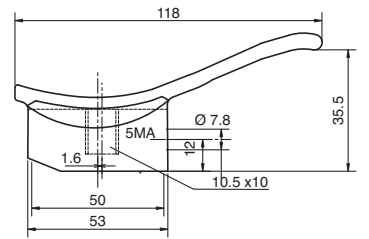

Art. 144

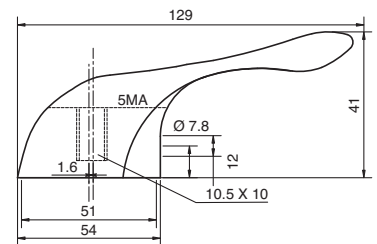
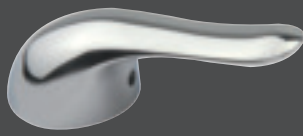

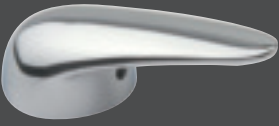

Art. 145

10

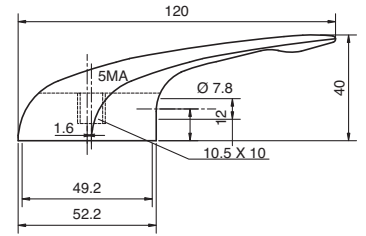

Art. 146

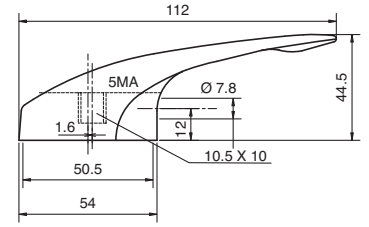

Art. 147

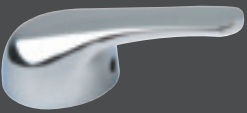
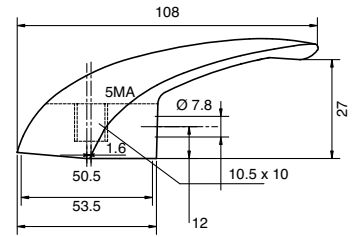

Art. 148

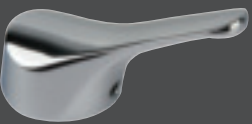
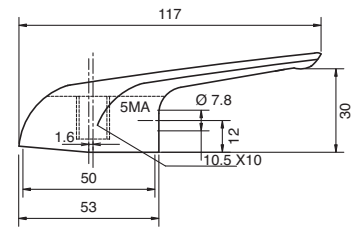

Art. 156

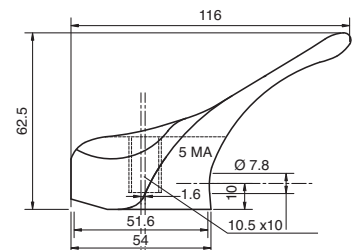

Art. 158

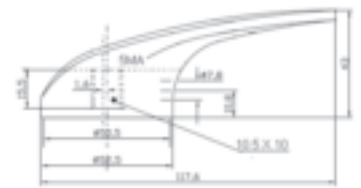

Aperte
Open

Art. 108

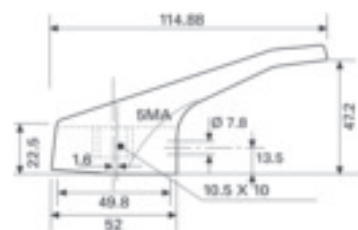

Leve monocomando Single-control levers





Art. 116

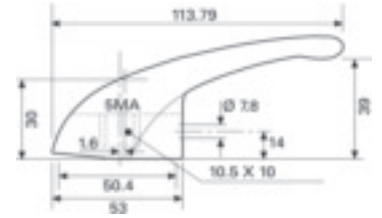

Art. 120

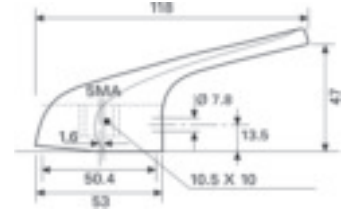

Art. 134

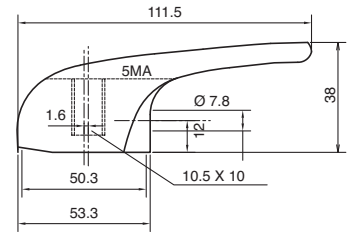

Art. 161

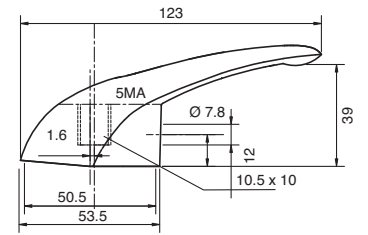

Art. 162

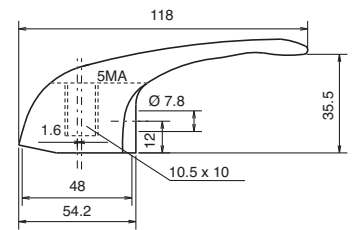

Leve monocomando Single-control levers



Leve per monocomando Ø 60 Single-control levers Ø 60



Art. 106

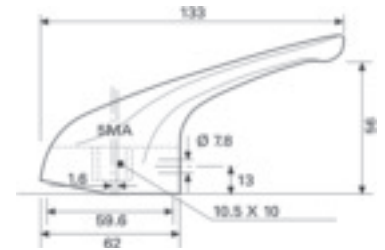

Art. 123

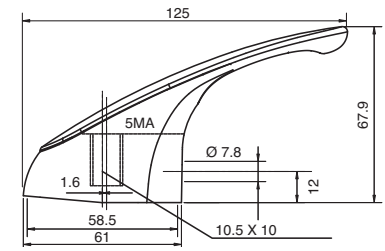

Leve monocomando Single-control levers



Leve cliniche per cartuccia Ø 35

Clinical levers for cartridges Ø 35

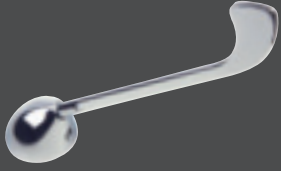

Art. 153

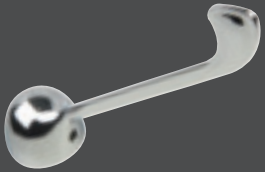
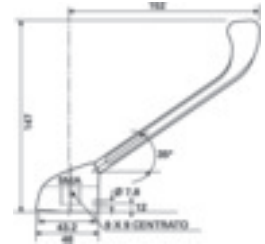

Art. 155

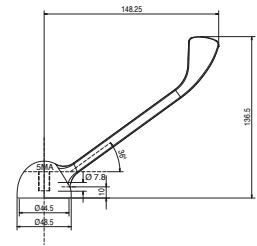

Leve cliniche *Clinical levers*

Leve cliniche per cartuccia Ø 40
Clinical levers for cartridges Ø 40

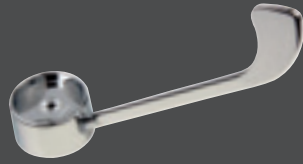

Art. 150

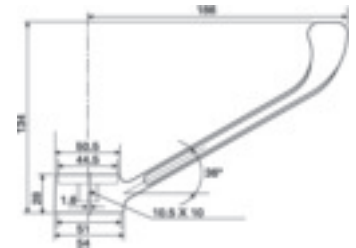

Art. 151

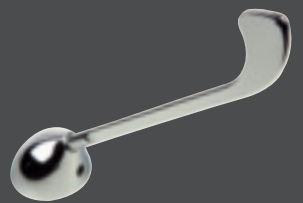
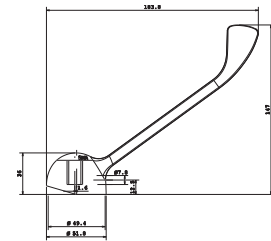

Art. 152

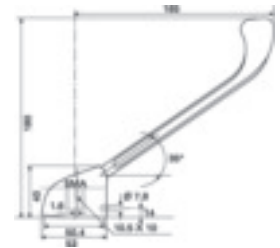

Art. 154

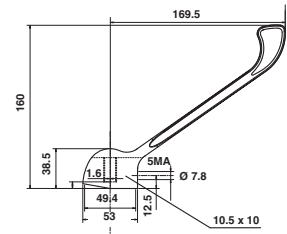

Leve cliniche *Clinical levers*



Basi per cartuccia Ø 35
 Bases for cartridges Ø 35

Art. 131B

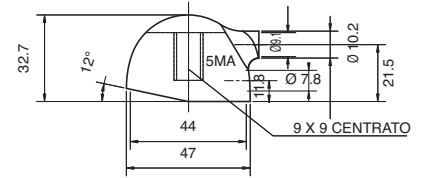

Art. 133B1

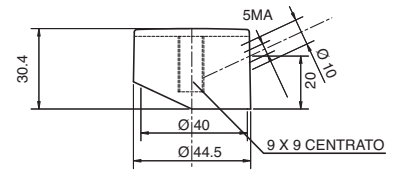

Art. 133B

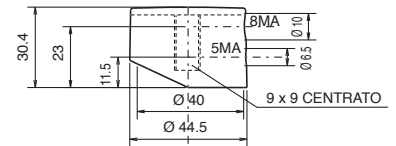

Art. 138B

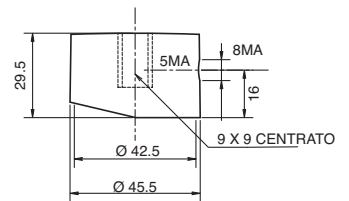

Art. 140B

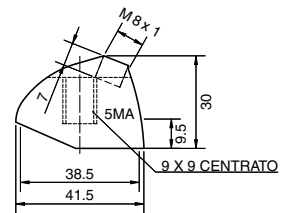

Art. 153B

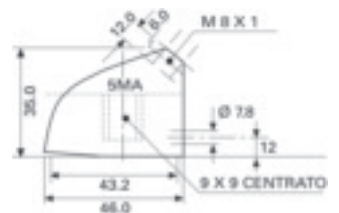

Basi Bases



Basi per cartuccia Ø 40+
Bases for catridges Ø 40+



Art. 130B

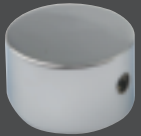
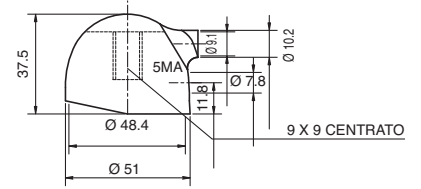

Art. 137B

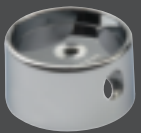
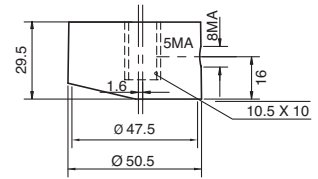

Art. 150B

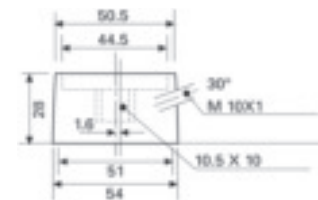

Art. 152B

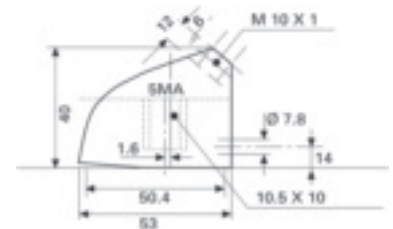

Basi Bases



Maniglie broccia 8x20 / 8x24
Handles with 8x20 / 8x24 broach



Art. M160

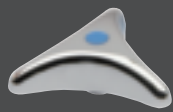

Art. M300

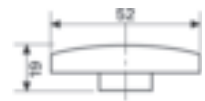

Art. M601



Art. M602



Art. M603

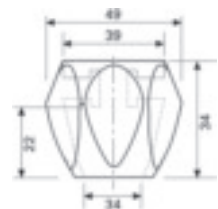

Art. M604

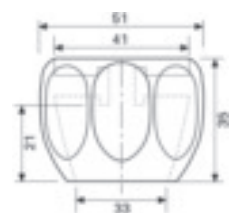

Maniglie Handles



Art. M605



Art. M606

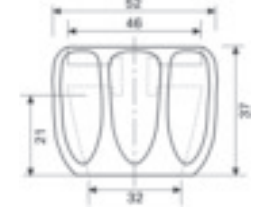

Art. M607

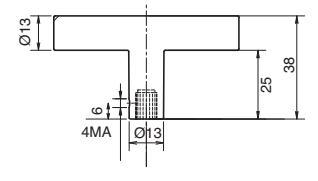

Art. M607F

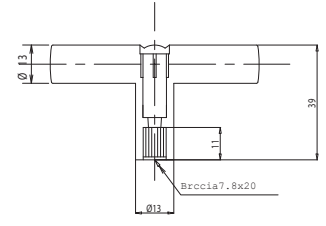

Art. M608

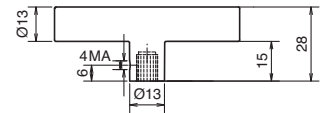

Art. M609

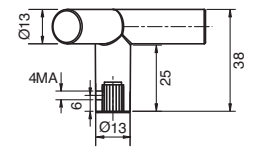

Art. M610

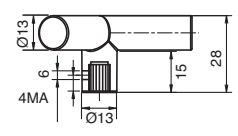

Maniglie Handles



Art. M611

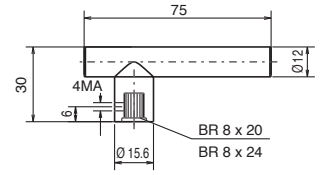

Art. M612

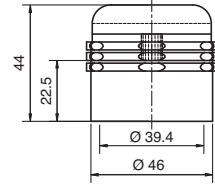

Maniglie Handles



Componenti per rubinetteria
 Tap components

Componenti per rubinetteria Tap components



Art. R201

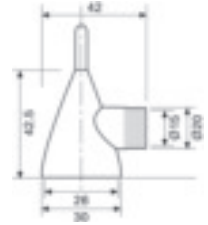

Art. R202

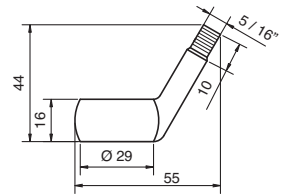

Art. R230

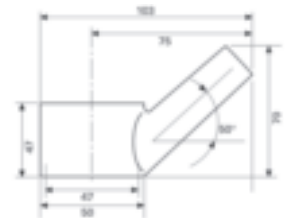

Art. R301



Art. R302

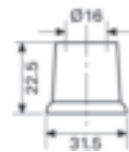

Art. R310



Art. R401

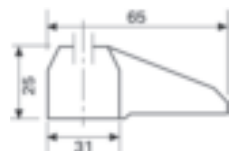

Componenti per rubinetteria Tap components



Art. R501

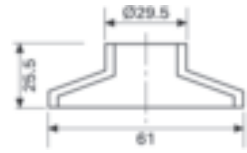

Art. R601

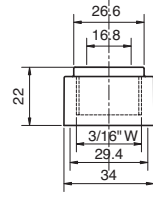

Art. R602

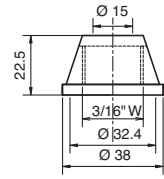

Soffioni Rainshowers

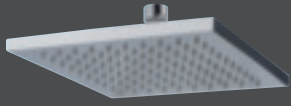

Art. D104

Soffione quadro 195 x 195

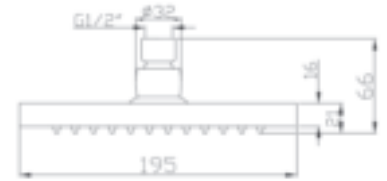

Art. D105

Soffione quadro 200 x 200

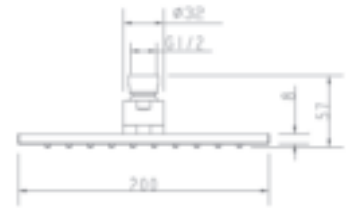

Art. D106

Soffione tondo ø 200

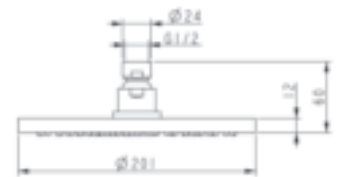

Art. D107

Soffione tondo ø 200

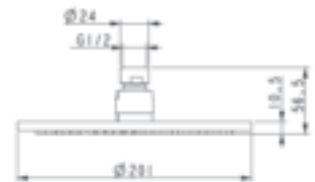

Art. D108

Braccio tondo 400 mm

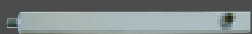

Art. D109

Braccio rettangolare 400 mm



Soffioni Rainshowers



Scarichi
Drains



Art. D101

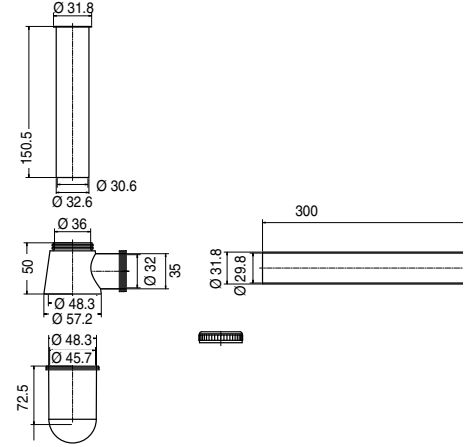

Art. D102

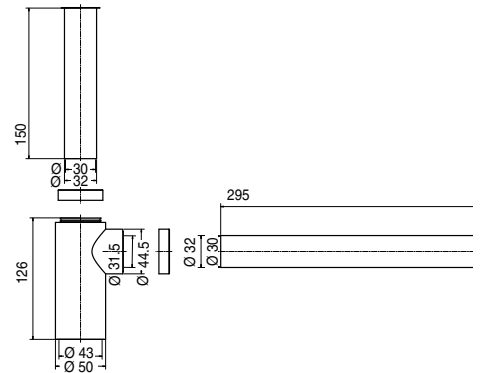

Art. D103

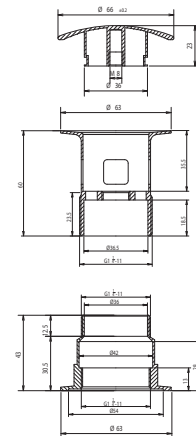

Scarichi Drains



Accessori Accessories

Accessori Accessories

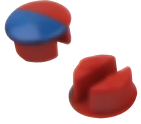

Art. V10
Tappino Ø 7,8
Cup Ø 7,8



Art. V11
Tappino Ø 7,8
Cup Ø 7,8



Art. V600R
Tappini per articoli
M601-M602-M605-M160
Cups for art.
M601-M602-M605-M160



Art. V600GB
Tappini per articoli
M601-M602-M605
Cups for art.
M601-M602-M605



Art. V603R
Rosone per articolo M603
Ring for art. M603



Art. V604B
Rosone per articolo M604
Ring for art. M604



Art. V606R
Rosone per articolo M606
Ring for art. M606

Art. V12
Tappino Ø 7,8
Cup Ø 7,8



Art. V30
Grano 5MA
Screw 5MA



Art. V600B
Tappini per articoli
M601-M602-M605-M160
Cups for art.
M601-M602-M605-M160

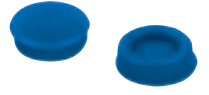

Art. V600GR
Tappini per articoli
M601-M602-M605
Cups for art.
M601-M602-M605



Art. V603B
Rosone per articolo M603
Ring for art. M603



Art. V604R
Rosone per articolo M604
Ring for art. M604



Art. V606B
Rosone per articolo M606
Ring for art. M606



Art. V603

Placchetta per articolo M603
Plastic cup for art. M603

**Art. V604**

Placchetta per articolo M604
Plastic cup for art. M604

**Art. V606**

Placchetta per articolo M606
Plastic cup for art. M606

**Art. V607**

Tappino per articolo M607F
Cup for art. M607F

**Art. V603SA**

Placchetta per articolo M603
Plastic cup for art. M603

**Art. V604SA**

Placchetta per articolo M604
Plastic cup for art. M604

**Art. V606SA**

Placchetta per articolo M606
Plastic cup for art. M606



Accessori Accessories



CERTIFICATO

**Sistema di gestione
EN ISO 9001:2000**

In base alla dimostrazione di conformità ai requisiti della norma suddetta, attestata in accordo con le procedure di certificazione, si dichiara che la società:



STILOPRESS S.r.l.
Via Antonini, 74
I - 25066 SAREZZO (BS)

attua un sistema di gestione per il seguente campo d'applicazione:

Progettazione e produzione di articoli in zama, componenti per la rubinetteria, leve monocomando e maniglie. Trattamenti galvanici.

N° di registrazione del certificato TIC 10 100 02714

Valido fino al 2011-03-10

Rapporto di audit n° 0330 25669 06

Prima Certificazione 2008

La presente certificazione è stata verificata in accordo alle procedure di certificazione e di auditing del TÜV CERT ed è soggetta ai regolari audit di sorveglianza.

TÜV Thüringen s.r.l.
Organismo di certificazione
di sistemi e del personale



Jena, 2008-02-14



www.stilopress.it - www.stilopress.com - info@stilopress.it - info@stilopress.com

Sede e stabilimento: Via Antonini, 74 - 25068 Sarezzo (Bs) Italy - Tel. +39 030 8900782 r.a. - Fax +39 030 8900865